

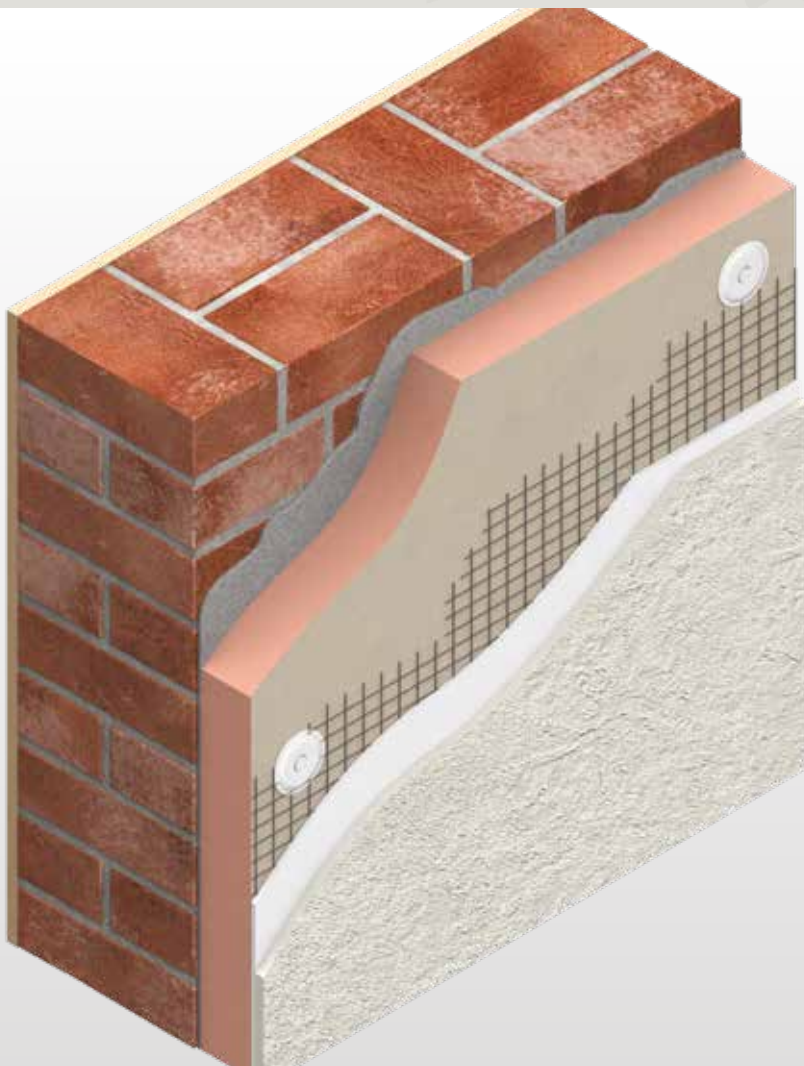

Kooltherm® K5 External Wall Board

EXTERNAL INSULATION FOR MASONRY WALLS



- Premium performance rigid thermoset insulation – thermal conductivities as low as 0.020 W/m·K
- Suitable for use behind traditional and lightweight polymer modified renders
- Unaffected by air infiltration
- Resistant to the passage of water vapour
- Easy to handle and install
- Ideal for new build and refurbishment
- Non-deleterious material
- Manufactured with a blowing agent that has zero ODP and low GWP

Fibre-free
Core

Kingspan®

*Low Energy –
Low Carbon Buildings*

Typical Constructions and U-values

Assumptions

The U-values in the tables that follow have been calculated, under a management system certified to the BBA Scheme for Assessing the Competency of Persons to Undertake U-value and Condensation Risk Calculations, using the method detailed in BS EN ISO 6946: 2017 / I.S. EN ISO 6946: 2007 (Building components and building elements. Thermal resistance and thermal transmittance. Calculation methods), and using the conventions set out in BR 443 (Conventions for U-value calculations). They are valid for the constructions shown in the details immediately above each table.



For the refurbishment examples, the internal wall finish is taken as 13 mm dense plaster unless stated otherwise. For the new build examples, the internal wall finish is taken to be a 3 mm skim coated 12.5 mm plasterboard on dabs, unless stated otherwise. In all examples, the external wall rendered finish is taken to be a 10 mm polymer render.

NB When calculating U-values to BS EN ISO 6946: 2017 / I.S. EN ISO 6946: 2007, the type of mechanical fixing used may change the thickness of insulation required. These calculations assume telescopic tube fasteners with a thermal conductivity of 1.00 W/m·K or less, the effect of which is insignificant.

NB For the purposes of these calculations the standard of workmanship has been assumed good, and therefore the correction factor for air gaps has been ignored.

NB The figures below are for guidance only. A detailed U-value calculation and a condensation risk analysis should be completed for each project.

NB If your construction is different from those specified, and / or to gain a comprehensive U-value calculation along with a condensation risk analysis of your project, please consult the Kingspan Insulation Technical Service Department for assistance (see rear cover).

U-value Table Key

Where an **X** is shown, the U-value is higher than the worst of the maximum new build area weighted average U-values allowed by the:

- 2013 editions of Approved Documents L to the Building Regulations for England;
- 2014 editions of Approved Documents L to the Building Regulations for Wales;
- 2015 editions of Technical Handbooks Section 6 to the Building Standards for Scotland;
- 2012 editions of Technical Booklets F1 & F2 to the Building Regulations for Northern Ireland; and
- 2011 edition of Technical Guidance Document L (Dwellings) and 2008 edition of Technical Guidance Document L (Buildings other than Dwellings) to the Building Regulations for the Republic of Ireland.

Refurbishment

100 mm Brick / 50 mm Cavity / 100 mm Brick Wall

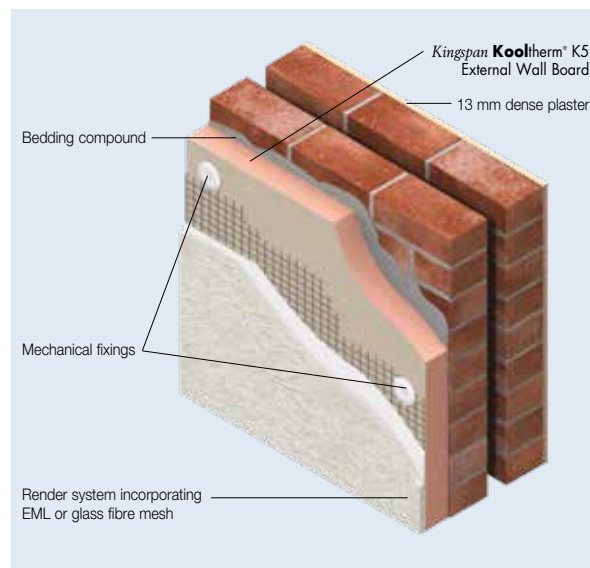

Figure 1

U-values for Various Thicknesses of Kingspan Kooltherm® K5 External Wall Board with 10 mm Polymer Render

Insulant Thickness (mm)	U-values (W/m ² ·K)
50	X
55	0.29
60	0.27
70	0.24
75	0.22
80	0.21
90	0.19
100	0.17
110	0.16
120	0.15

NB Refer to local distributor or Kingspan Insulation price list for current stock and non-stock sizes.

Solid Brick Wall

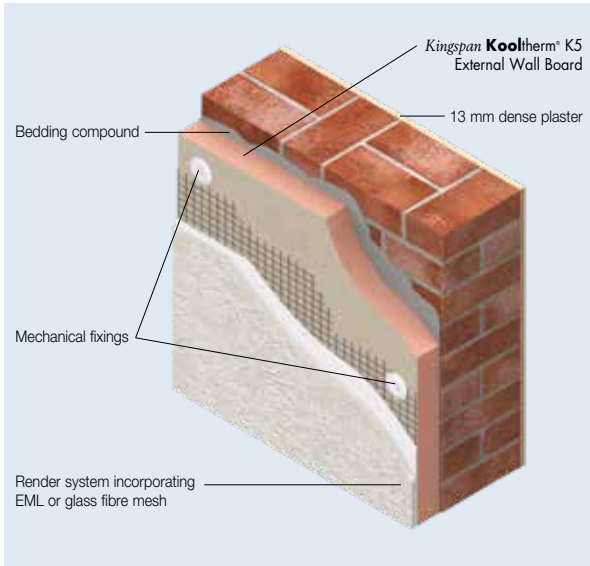

Figure 2

U-values (W/m ² :K) for Various Thicknesses of Kingspan Kooltherm® K5 External Wall Board on Different Thicknesses of Brickwork with 10 mm Polymer Render		
Insulant Thickness (mm)	Brickwork Thickness (mm)	
	102.5	215
50	X	X
55	X	0.30
60	0.29	0.28
70	0.26	0.25
75	0.24	0.23
80	0.23	0.22
90	0.20	0.20
100	0.18	0.18
110	0.17	0.17
120	0.16	0.15

NB Refer to local distributor or Kingspan Insulation price list for current stock and non-stock sizes.

102.5 mm Brick / 50 mm Cavity / 100 mm Block Wall

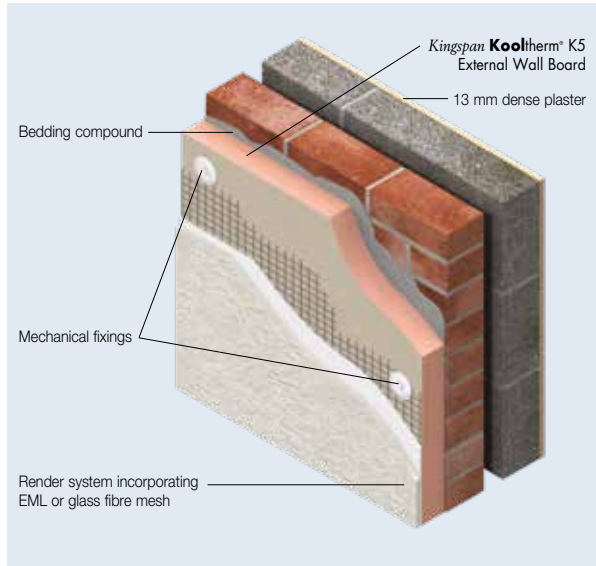

Figure 3

U-values (W/m ² :K) for Various Thicknesses of Kingspan Kooltherm® K5 External Wall Board with 10 mm Polymer Render				
Insulant Thickness (mm)	Inner Leaf Blockwork Density and λ-value (W/m-K)			
	Dense (1.13)	Medium (0.51)	Lightweight (0.15)*	Aerated (0.11)*
40	X	X	X	X
45	X	X	0.29	0.28
50	X	0.30	0.27	0.26
55	0.29	0.28	0.26	0.25
60	0.27	0.26	0.24	0.23
70	0.24	0.23	0.21	0.21
75	0.23	0.22	0.20	0.20
80	0.21	0.21	0.19	0.19
90	0.19	0.19	0.18	0.17
100	0.18	0.17	0.16	0.16
110	0.16	0.16	0.15	0.15
120	0.15	0.15	0.14	0.14

* A 6.6% thermal bridging factor has assumed for the effect of mortar joints.

NB Refer to local distributor or Kingspan Insulation price list for current stock and non-stock sizes.

Typical Constructions and U-values

100 mm Dense Block* / 50 mm Cavity / 100 mm Dense Block* Wall (Original Render Removed)

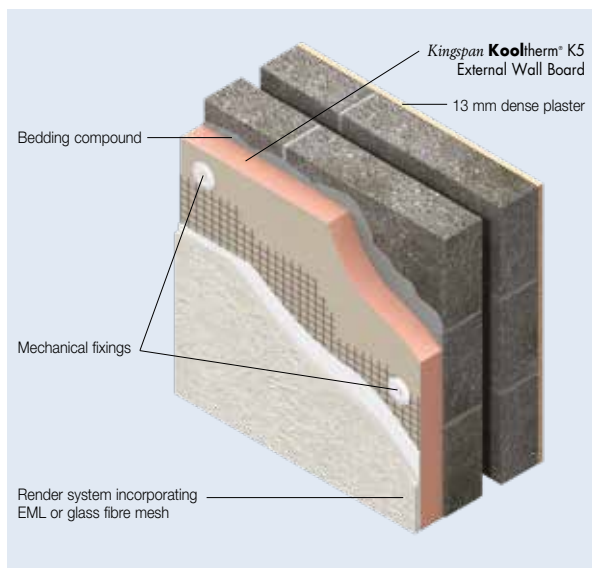

Figure 4

New Build

215 mm Solid Blockwork Wall

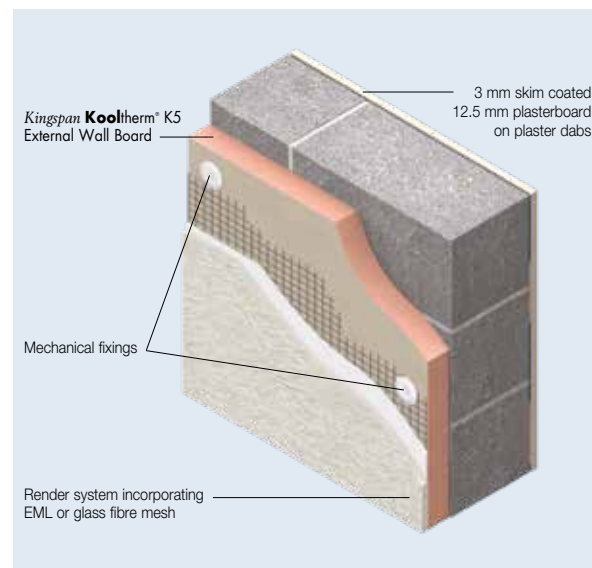

Figure 5

U-values for Various Thicknesses of Kingspan Kooltherm® K5 External Wall Board with 10 mm Polymer Render

Insulant Thickness (mm)	U-values (W/m ² ·K)
50	X
55	0.29
60	0.27
70	0.24
75	0.23
80	0.22
90	0.19
100	0.18
110	0.16
120	0.15

* Calculations assume dense block of λ -value 1.13 W/m·K.

NB Refer to local distributor or Kingspan Insulation price list for current stock and non-stock sizes.

U-values (W/m²·K) for Various Thicknesses of Kingspan Kooltherm® K5 External Wall Board with 10 mm Polymer Render

Insulant Thickness (mm)	Blockwork Density and λ -value (W/m·K)				
	Dense (1.13)	Medium (0.51)	Lightweight (0.15)*	Aerated (0.11)*	Thin Joint Aerated (0.11)**
20	X	X	X	0.35	0.34
25	X	X	0.35	0.31	0.31
30	X	X	0.32	0.29	0.28
40	X	X	0.28	0.25	0.25
45	0.34	0.32	0.26	0.23	0.23
50	0.32	0.30	0.24	0.22	0.22
60	0.27	0.26	0.21	0.20	0.20
70	0.24	0.23	0.19	0.18	0.18
75	0.23	0.22	0.18	0.17	0.17
80	0.21	0.21	0.18	0.17	0.16
90	0.19	0.19	0.16	0.15	0.15
100	0.18	0.17	0.15	0.14	0.14
110	0.16	0.16	0.14	0.13	0.13
120	0.15	0.15	0.13	0.12	0.12

* A 6.6% thermal bridging factor has assumed for the effect of mortar joints.

** A 1.4% thermal bridging factor has assumed for the effect of mortar joints.

NB Refer to local distributor or Kingspan Insulation price list for current stock and non-stock sizes.

**100 mm Dense Block* Outer Leaf / 50 mm Cavity /
100 mm Block Inner Leaf**

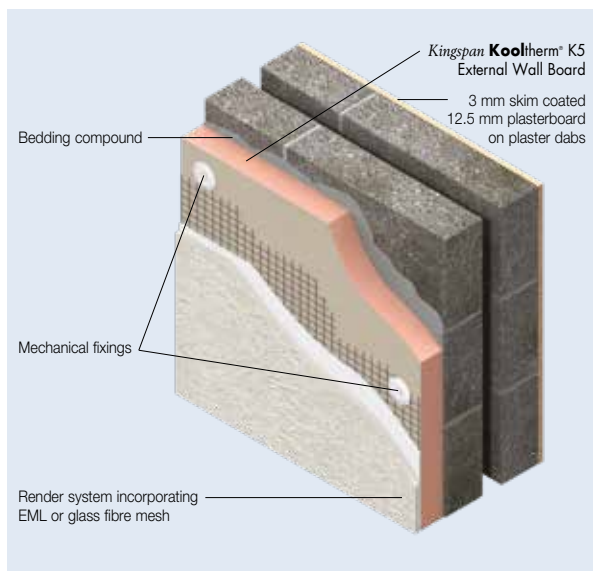

Figure 6

Insulant Thickness (mm)	Inner Leaf Blockwork Density and λ -value (W/m-K)				
	Dense (1.13)	Medium (0.51)	Lightweight (0.15)**	Aerated (0.11)**	Thin Joint Aerated (0.11)***
25	X	X	X	X	X
30	X	X	X	0.35	0.34
35	X	X	0.34	0.32	0.32
40	X	0.35	0.31	0.30	0.29
45	0.33	0.31	0.28	0.27	0.27
50	0.30	0.29	0.26	0.25	0.25
60	0.26	0.25	0.23	0.22	0.22
70	0.23	0.23	0.21	0.20	0.20
75	0.22	0.21	0.20	0.19	0.19
80	0.21	0.20	0.19	0.18	0.18
90	0.19	0.18	0.17	0.17	0.17
100	0.17	0.17	0.16	0.15	0.15
110	0.16	0.16	0.15	0.14	0.14
120	0.15	0.14	0.14	0.13	0.13

* Calculations assume dense block of λ -value 1.13 W/m-K

** A 6.6% thermal bridging factor has been assumed for the effect of mortar joints.

*** A 1.4% thermal bridging factor has assumed for the effect of mortar joints.

NB Refer to local distributor or Kingspan Insulation price list for current stock and non-stock sizes.

Linear Thermal Bridging at Junctions

Basic Principles

Linear thermal bridging describes the heat loss / gain that occurs at junctions between elements e.g. where an external wall meets the roof, or at junctions around openings in the building fabric where thermal insulation is discontinuous e.g. sills, jambs and lintels.

Interruptions within the insulation by materials with poorer insulating properties can result in a thermal bridge, which can lead to problems of condensation and mould growth, especially if there is a drop in surface temperature.

The heat flow at these junctions and opening locations, over and above that through the adjoining plane elements is the linear thermal transmittance of the thermal bridge: measured in W/m²·K; referred to as a 'psi-value'; and expressed as a ψ -value.

The lower the ψ -value, the better the performance. ψ -values are taken into account in the calculation methodologies e.g. Standard Assessment Procedure (SAP) that are used to assess the operational CO₂ emissions and the fabric energy efficiency of new buildings. ψ -values can comprise approved, calculated or assumed values.

Existing building junction losses are not typically accounted for in whole building heat loss calculations and only the risks of surface condensation and mould growth are considered.

Reducing Linear Thermal Bridging

Heat typically flows through the easiest path. For a wall insulated with Kingspan Kooltherm® K5 External Wall Board the main linear thermal bridges are the reveals, the junction between the walls and the roof, and where the external wall and ground floor meet.

Whilst there are some 'approved' details available for External Wall Insulation (EWI), they are largely targeted at new build constructions. However, they are also considered good practice for refurbishment.

Detailing at junctions to minimise the effects of thermal bridging and the associated risk of condensation or mould growth is important and there are some simple design considerations that can be adopted when insulating to help mitigate the risks and to reduce heat loss.

Continuity of insulation is the best approach to limit losses through junctions. Failing continuity, overlap of insulation layers and use of lower conductivity materials represents a good practice approach. However, where neither option is possible, the risk of condensation will require particular consideration in determining an appropriate approach. Details and designs should be considered in the context of the property, its construction, characteristics, condition and ventilation provisions.

Typical Constructions and U-values

Where insulating externally or sheathing a frame construction, there are some simple design considerations that can be adopted to help reduce heat losses.

- The reveal linear thermal bridge can be avoided either by positioning the window frame so that its outer face is flush with the outer surface of the masonry wall, and overlapping the window frame with the external wall insulation. Or, if this is not possible, the linear thermal bridge can be reduced by insulating the reveal at jambs, head and sill. The key factor is the thermal resistance (R-value) of this insulation layer.
- Reveals should be designed to accommodate the 20 mm of **Kingspan Kooltherm® K5 External Wall Board** required to achieve an R-value of 0.6 m²-K/W, and the depth of the cladding system (see Figure 7).

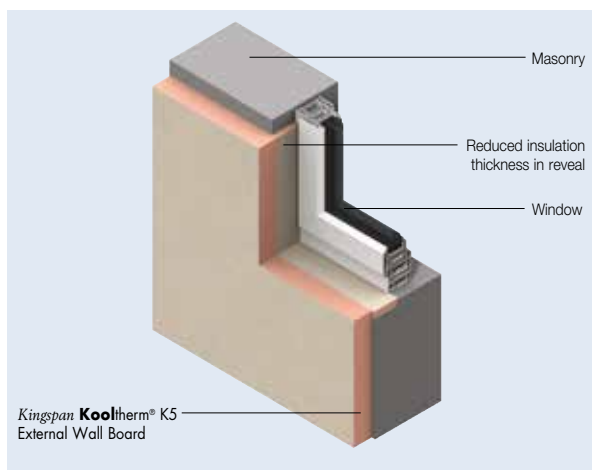

Figure 7

- Heat loss through reveal junctions can also be reduced by internally accommodating 32.5 mm (min.) of **Kingspan Kooltherm® K118 Insulated Plasterboard** around the openings.
 - Where existing windows or doors are not replaced as part of renovation works, design and detailing should consider the potential for future replacement works.
 - At ground floor junctions where **Kingspan Kooltherm® K5 External Wall Board** is used on an existing substrate, good practice is to extend the insulation below the starter rail as an insulated plinth to ground level (for example using **Kingspan Purlcrete® chevron**). Best practice would be to excavate and extend the external insulation below ground level by at least 300 mm below finished floor level to increase the heat flow path and reduce junction losses. A starter rail / track formed from a low conductivity material can also help to reduce losses through this junction.
- For a new build construction, where **Kingspan Kooltherm® K5 External Wall Board** is used to sheath a frame construction at the edge of ground floors, the distance between the top surface of the floor insulation or perimeter insulation upstand, and the bottom of the wall insulation must be a minimum of 150 / 225* mm for a concrete floor and 200 mm for a suspended timber floor. The further appropriate wall insulation extends past the floor insulation, the better the thermal performance of the junction between the wall and the floor will be.
* 150 mm applies to the UK and 225 mm to the Republic of Ireland.
 - At junctions with roofs, **Kingspan Kooltherm® K5 External Wall Board** has an advantage over other systems, in that the overall reduced thickness of the system may be accommodated within the existing eaves and gables overhang. This can avoid the necessity of either a step out from the eaves at the wall insulation, or for extending the roof eaves or verge over the external wall insulation system. Loft insulation should overhang the externally applied insulation layer effectively to avoid a significant thermal bridge occurring. Best practice where the overhang is insufficient to accommodate **Kingspan Kooltherm® K5 External Wall Board** should be to extend the existing roof and to maintain continuity of insulation between the roof and walls.
 - Best practice should be to reposition existing rainwater guttering and downpipes, maintaining continuity of insulation (and reducing losses from the junction) whilst also increasing robustness at interfaces to reduce the risk of water entering and damaging the **Kingspan Kooltherm® K5 External Wall Board**.
 - It is also important to consider other obstructions to the continuity of insulation, such as meter boxes, satellite dishes, flues, ventilation ducts and grilles, and gas and mains water connections. Best practice should be for these to be removed and re-fixed to the surface of the external wall finish to ensure continuity of insulation by appropriate persons/agencies.
 - There will be instances where separation from flues / air ducts and combustible material is required and appropriate instructions and guidance should be sought and followed where applicable.

For further advice on details to reduce linear thermal bridging please contact the Kingspan Insulation Technical Service Department (see rear cover for details).

Design Considerations

Environmental Impact & Responsible Sourcing

Green Guide Rating

An Ecoprofile, certified by BRE Certification to the 2008 BRE Environmental Profiles Methodology, has been created for **Kingspan Kooltherm® K5 External Wall Board** produced at Kingspan Insulation's Pembridge manufacturing facility. The BRE has assigned the product a 2008 Green Guide Summary Rating of A+.



Environmental Profiles Scheme
Certificate Number ENP 500

Responsible Sourcing

Kingspan Kooltherm® K5 External Wall Board produced at Kingspan Insulation's Pembridge manufacturing facility is certified to BES 6001 (Framework Standard for the Responsible Sourcing of Construction Products) 'Excellent'.



Kingspan Kooltherm® K5 External Wall Board produced at Kingspan Insulation's Pembridge and Castleblayney manufacturing facilities is manufactured under a management system certified to ISO 14001: 2004.

NB The above information is correct at the time of writing. Please confirm at the point of need by contacting Kingspan Insulation's Technical Service Department (see rear cover), from which copies of Kingspan Insulation's certificates can be obtained.

Sustainability & Responsibility

Kingspan Insulation has a long-term commitment to sustainability and responsibility: as a manufacturer and supplier of insulation products; as an employer; as a substantial landholder; and as a key member of its neighbouring communities.

A report covering the sustainability and responsibility of Kingspan Insulation Ltd's British operations at its Pembridge, Herefordshire and Selby, North Yorkshire manufacturing facilities is available at www.kingspaninsulation.co.uk/sustainabilityandresponsibility.

Specification Clause

Kingspan Kooltherm® K5 External Wall Board should be described in specifications as:-

The external wall insulation shall be **Kingspan Kooltherm® K5 External Wall Board** ____ mm thick: comprising a premium performance rigid thermoset insulation core faced on both sides with a glass tissue based facing. The product shall be manufactured: with a blowing agent that has zero Ozone Depletion Potential (ODP) and low Global Warming Potential (GWP); under a management system certified to ISO 9001: 2008, ISO 14001: 2004, BS / I.S. OHSAS 18001: 2007 and ISO 50001: 2011; by Kingspan Insulation Limited; and installed in accordance with the instructions issued by them.

NBS Specifications

Details also available in NBS Plus.

NBS users should refer to clause(s):

M21 210, M21 220, M21 230

(Standard and Intermediate)

M21 20 (Minor Works)



Building Information Modelling (BIM)

Kingspan Insulation's BIM objects can be downloaded in Revit and in IFC formats. For more information please visit www.kingspaninsulation.co.uk/bim.

Water Vapour Control / Condensation

Consideration should be given to the risk of condensation, when designing thermal elements.

A condensation risk analysis should be carried out following the procedures set out in BS 5250: 2011 + A1: 2016 (Code of practice for the control of condensation in buildings). The Kingspan Insulation Technical Service Department (see rear cover) can provide this service.

Fire Stops

Current Building Regulations / Standards should be considered with regard to the requirements for, and provision of, fire stops.

Sitework

Insulated Render Systems

- Because insulated render systems are proprietary and utilise different mechanisms for attaching insulation to the wall structure, sitework guidance should always be sought from the render system manufacturer. However, in the absence of any other guidance, the instructions laid out below may be followed.
- Insulated render systems above 18 metres may require a full scale fire test. Please consult your system supplier for more information.
- The external masonry wall should be clean, flat, and free from protrusions.
- Where an uneven surface remains, it is recommended that a bedding compound can be applied prior to securing the insulation boards in place.
- External wall insulation should start 150 / 200 / 600* mm below the top surface of the ground floor insulation / perimeter insulation upstand (whichever is higher) for a concrete floor, or 200 mm below the top surface of the ground floor insulation / perimeter insulation upstand (whichever is higher) for a suspended timber floor.

* 150 mm applies to the UK. 200 mm applies to the Republic of Ireland if a row of insulating blockwork (thermal conductivity < 0.20 W/m·K) is used, otherwise 600 mm applies.

- Insulation boards should be installed break-bonded, with joints lightly butted.
- Insulation boards are to be restrained to the substrate with adhesive and mechanical fixings when the system is to be fixed to an existing building.
- Care should be taken to install the specified thickness of insulation around reveals (see Figure 7).
- Boards of **Kingspan Kooltherm® K5 External Wall Board** are mechanically fixed to the exterior of masonry external walls, preferably using thermally broken telescopic tube fasteners.
- A minimum of 5 fixings are required to secure an insulation board to the masonry wall.
- Board edges at openings and external corners should be fixed with fasteners at maximum 300 mm centres.
- Fasteners at board edges must be located > 50 mm, and < 150 mm, from edges and corners of the board, and not overlap board joints.
- The requirement for additional fixings is dependent on the render system being applied and the type of fixing being used.

For details on fixings refer to:

Ejot UK Limited www.ejot.co.uk	+44 (0) 1977 687 040
Helifix Limited www.helifix.co.uk	+44 (0) 2087 355 222
MAK Fasteners www.makfasteners.com	+353 (0) 1 451 99 00

SFS Intec +44 (0) 1132 085 500

www.sfsintec.biz/uk

Wallfast Limited +44 (0) 2392 298 443

www.wallfast.co.uk

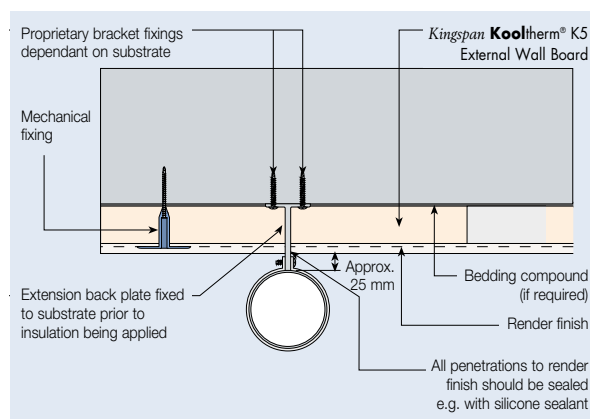

Figure 8 – Drainpipe Extension Detail (Applicable to a Variety of External Building Ancillaries)

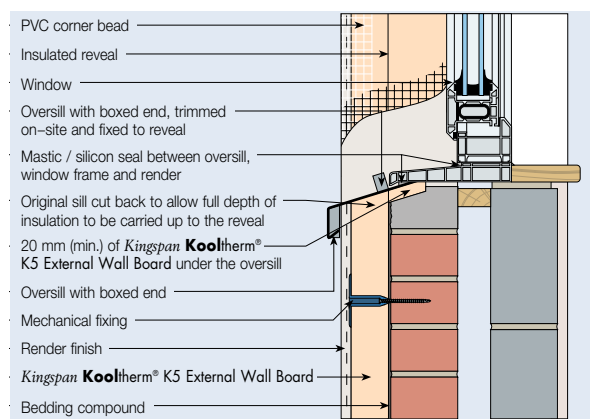

Figure 9 – Oversill Extension Detail (Refurbishment)

- Wherever possible, care should be taken to avoid cold bridging when attaching services and ancillaries to the exterior of the building (see Figure 8).
- Depending on the render finish being applied, advice must be sought from the render manufacturer on the EML / glass fibre mesh and bedding mortar to be applied.
- Base cementitious render application should be in two coats, incorporating a scrim reinforcement layer between them, then completed with a finishing coat. All render coats should be strictly applied in accordance with the system suppliers accreditation and their current application guidance, paying particular attention to thickness and cure times between layers.
- Minimum total render thicknesses should average 8 mm and not drop below 6 mm at any point.
- In refurbishment projects, sill extenders and flashings should be used around openings, with care taken to avoid cold bridging (see Figure 9).

General

Cutting

- Cutting should be carried out either by using a fine toothed saw, or by scoring with a sharp knife, snapping the board over a straight edge and then cutting the facing on the other side.
- Ensure accurate trimming to achieve close-butting joints and continuity of insulation.

Daily Working Practice

- At the completion of each day's work, or whenever work is interrupted for extended periods of time, board edges and joints should be protected from inclement weather.

Availability

- *Kingspan Kooltherm*® K5 External Wall Board is available through specialist insulation distributors and selected builders' merchants throughout the UK and Ireland.

Packaging and Storage

- The polyethylene packaging of Kingspan Insulation products, which is recyclable, should not be considered adequate for outdoor protection.
- Ideally, boards should be stored inside a building. If, however, outside storage cannot be avoided, then the boards should be stacked clear of the ground and covered with an opaque polythene sheet or weatherproof tarpaulin. Boards that have been allowed to get wet should not be used.

Health and Safety

- Kingspan Insulation products are chemically inert and safe to use.
- A Safety Information Data Sheet for this product is available from the Kingspan Insulation website www.kingspaninsulation.co.uk/safety or www.kingspaninsulation.ie/safety.

Warning – do not stand on or otherwise support your weight on this product unless it is fully supported by a load bearing surface.

Product Details

The Facings

Kingspan Kooltherm® K5 External Wall Board is faced on both sides with a glass tissue based facing, autohesively bonded to the insulation core during manufacture.

The Core

The core of *Kingspan Kooltherm*® K5 External Wall Board is a premium performance fibre-free rigid thermoset modified resin insulant manufactured with a blowing agent that has zero Ozone Depletion Potential (ODP) and low Global Warming Potential (GWP).



Standards and Approvals

Kingspan Kooltherm® K5 External Wall Board is manufactured to the highest standards under a management system certified to ISO 9001: 2008 (Quality management systems. Requirements), ISO 14001 : 2004 (Environmental Management Systems. Requirements), BS / I.S OHSAS 18001: 2007 (Occupational Health and Safety Management Systems. Requirements) and ISO 50001: 2011 (Energy Management Systems. Requirements with guidance for use).

Kingspan Kooltherm® K5 External Wall Board is used as an integral component of several BBA / NSAI Agrément Certified rendered external wall insulation systems. For further details of BBA / NSAI Agrément Certification please contact the Kingspan Insulation Technical Service Department (see rear cover).

Standard Dimensions

Kingspan Kooltherm® K5 External Wall Board is available in the following standard size:

Nominal Dimension		Availability
Length	(m)	1.2
Width	(m)	0.6
Insulant Thickness	(mm)	Refer to local distributor or Kingspan Insulation price list for current stock and non-stock sizes.

Compressive Strength

The compressive strength of *Kingspan Kooltherm*® K5 External Wall Board typically exceeds 120 kPa when tested to BS / I.S. EN 826: 2013 (Thermal insulating products for building applications. Determination of compression behaviour).

Product Details

Water Vapour Resistivity

The product typically achieves a resistivity greater than 300 MN·s/g·m, when tested in accordance with BS / I.S. EN 12086: 2013 (Thermal insulating products for building applications Determination of water vapour transmission properties).

Durability

If correctly installed, *Kingspan Kooltherm*® K5 External Wall Board can have an indefinite life. Its durability depends on the supporting structure and the conditions of its use.

Resistance to Solvents, Fungi & Rodents

The insulation core is resistant to short-term contact with petrol and with most dilute acids, alkalis and mineral oils. However, it is recommended that any spills be cleaned off fully before the boards are installed. Ensure that safe methods of cleaning are used, as recommended by suppliers of the spilt liquid. The insulation core is not resistant to some solvent-based adhesive systems, particularly those containing methyl ethyl ketone. Adhesives containing such solvents should not be used in association with this product. Damaged boards or boards that have been in contact with harsh solvents or acids should not be used.

The insulation core and facings used in the manufacture of *Kingspan Kooltherm*® K5 External Wall Board resist attack by mould and microbial growth and do not provide any food value to vermin.

Fire Performance

Kingspan Kooltherm® K5 External Wall Board achieves Class 0 Rating, as defined by Approved Document B in England and Wales, and Technical Booklet E in Northern Ireland. It also achieves medium risk, as defined in the Technical Handbook in Scotland.

Kingspan Kooltherm® K5 External Wall Board when subjected to EN ISO 5659-2: 2012 (Plastics. Smoke generation. Part 2: Determination of optical density by a single-chamber test), has achieved a mean maximum specific optical density of smoke < 200 in both the presence and absence of a pilot flame at irradiances of 25 and 50 kW/m².

Further details of the fire performance of Kingspan Insulation products may be obtained from the Kingspan Insulation Technical Service Department (see rear cover).

Thermal Properties

The λ -values and R-values detailed below are quoted in accordance with BS / I.S. EN 13166: 2012 + A1: 2015 (Thermal insulation products for buildings – Factory made products of phenolic foam (PF) – Specification).

Thermal Conductivity

The boards achieve a thermal conductivity (λ -value) of: 0.023 W/m·K (insulant thickness 15–24 mm); 0.021 W/m·K (insulant thickness 25–44 mm); and 0.020 W/m·K (insulant thickness \geq 45 mm).

Thermal Resistance

Thermal resistance (R-value) varies with thickness and is calculated by dividing the thickness of the board (expressed in metres) by its thermal conductivity. The resulting number is rounded down to the nearest 0.05 (m²·K/W).

Insulant Thickness (mm)	Thermal Resistance (m ² ·K/W)
20	0.85
25	1.15
30	1.40
35	1.65
40	1.90
45	2.25
50	2.50
55	2.75
60	3.00
70	3.50
75	3.75
80	4.00
90	4.50
100	5.00
110	5.50
120	6.00

Refer to local distributor or Kingspan Insulation price list for current stock and non-stock sizes.

Kingspan Insulation

Company Details

Kingspan Insulation Ltd is part of the Kingspan Group plc., one of Europe's leading construction product manufacturers. The Kingspan Group was formed in the late 1960s and is a publicly quoted group of companies headquartered in Kingscourt, County Cavan, Ireland.

Kingspan Insulation Ltd is a market leading manufacturer of premium and high performance rigid insulation products and insulated systems for building fabric and building services applications.

Products & Applications

Kingspan Insulation Ltd has a vast product range. Kingspan Insulation Ltd products are suitable for both new build and refurbishment in a variety of applications within both domestic and non-domestic buildings.

Insulation for:

- Pitched Roofs
- Flat Roofs
- Green Roofs
- Cavity Walls
- Solid Walls
- Timber and Steel Framing
- Insulated Cladding Systems
- Insulated Render Systems
- Floors
- Soffits
- Ductwork

Further Solutions:

- Insulated Dry-Lining
- Tapered Roofing Systems
- Cavity Closers
- **Kingspan KoolDuct**® Pre-Insulated Ducting
- **Kingspan nilvent**® Breathable Membranes
- **Kingspan TEK**® Building System

Insulation Product Benefits

Kingspan **OPTIM-R**® Vacuum Insulation Panel (VIP)

Products

- With a declared value thermal conductivity of 0.007 W/m·K, these products provide an insulating performance that is up to five times better than commonly used insulation materials.
- Provides high levels of thermal efficiency with minimal thickness.
- Over 90% (by weight) recyclable.

Kingspan **Kooltherm**® Range Products

- With a thermal conductivity of 0.018–0.023 W/m·K these are the most thermally efficient insulation products commonly used.
- The thinnest commonly used insulation products for any specific U-value.
- Manufactured with a blowing agent that has zero Ozone Depletion Potential (ODP) and low Global Warming Potential (GWP).

Kingspan **Therma**™ Range Products

- With a thermal conductivity of 0.022–0.028 W/m·K these are amongst the more thermally efficient insulation products commonly used.
- Manufactured with a blowing agent that has zero Ozone Depletion Potential (ODP) and low Global Warming Potential (GWP).

Kingspan **Styrozone**® Range Products

- Rigid extruded polystyrene insulation (XPS) has the necessary compressive strength to make it the product of choice for specialist applications such as heavy duty flooring, car park decks and inverted roofing.
- Manufactured with a blowing agent that has zero Ozone Depletion Potential (ODP).

All Products

- Unaffected by air infiltration – a problem that can be experienced with mineral fibre and which can reduce thermal performance.
- Safe and easy to install.
- If installed correctly, can provide reliable long term thermal performance over the lifetime of the building.
- Each product achieves the required fire performance for its intended application.

Contact Details

Customer Service

For quotations, order placement and details of despatches please contact the Kingspan Insulation Customer Service Department on the numbers below:

UK – Tel: +44 (0) 1544 388 601
– Fax: +44 (0) 1544 388 888
– email: customerservice@kingspaninsulation.co.uk

Ireland – Tel: +353 (0) 42 979 5000
– Fax: +353 (0) 42 975 4299
– email: info@kingspaninsulation.ie

Literature & Samples

Kingspan Insulation produces a comprehensive range of technical literature for specifiers, contractors, stockists and end users. The literature contains clear user friendly advice on typical design; design considerations; thermal properties; sitework and product data.

For copies please contact the Kingspan Insulation Marketing Department, or visit the Kingspan Insulation website, using the details below:

UK – Tel: +44 (0) 1544 387 384
– Fax: +44 (0) 1544 387 484
– email: literature@kingspaninsulation.co.uk
– www.kingspaninsulation.co.uk/literature

Ireland – Tel: +353 (0) 42 979 5000
– Fax: +353 (0) 42 975 4299
– email: info@kingspaninsulation.ie
– www.kingspaninsulation.ie/literature

Tapered Roofing

For technical guidance, quotations, order placement and details of despatches please contact the Kingspan Insulation Tapered Roofing Department on the numbers below:

UK – Tel: +44 (0) 1544 387 383
– Fax: +44 (0) 1544 387 483
– email: tapered@kingspaninsulation.co.uk

Ireland – Tel: +353 (0) 42 975 4297
– Fax: +353 (0) 42 975 4296
– email: tapered@kingspaninsulation.ie

Technical Advice / Design

Kingspan Insulation supports all of its products with a comprehensive Technical Advisory Service. Calculations can be carried out to provide U-values, condensation / dew point risk, required insulation thicknesses etc...

U-value calculations can also be carried out on the Kingspan Insulation U-value Calculator, available for free online at www.uvalue-calculator.co.uk or downloaded as an App.



The Kingspan Insulation Technical Service Department can also give general application advice and advice on design detailing and fixing etc... Site surveys are also undertaken as appropriate.

The Kingspan Insulation British Technical Service Department operates under a management system certified to the BBA Scheme for Assessing the Competency of Persons to Undertake U-value and Condensation Risk Calculations.



Please contact the Kingspan Insulation Technical Service Department on the numbers below:

UK – Tel: +44 (0) 1544 387 382
– Fax: +44 (0) 1544 387 482
– email: technical@kingspaninsulation.co.uk

Ireland – Tel: +353 (0) 42 975 4297
– Fax: +353 (0) 42 975 4296
– email: technical@kingspaninsulation.ie

General Enquiries

For all other enquiries contact Kingspan Insulation on the numbers below:

UK – Tel: +44 (0) 1544 388 601
– Fax: +44 (0) 1544 388 888
– email: info@kingspaninsulation.co.uk

Ireland – Tel: +353 (0) 42 979 5000
– Fax: +353 (0) 42 975 4299
– email: info@kingspaninsulation.ie

Kingspan Insulation Ltd. reserves the right to amend product specifications without prior notice. Product thicknesses shown in this document should not be taken as being available ex-stock and reference should be made to the current Kingspan Insulation price-list or advice sought from Kingspan Insulation's Customer Service Department (see above left). The information, technical details and fixing instructions etc. included in this literature are given in good faith and apply to uses described. Recommendations for use should be verified for suitability and compliance with actual requirements, specifications and any applicable laws and regulations. For other applications or conditions of use, Kingspan Insulation offers a Technical Advisory Service (see above), the advice of which should be sought for uses of Kingspan Insulation products that are not specifically described herein. Please check that your copy of this literature is current by contacting the Kingspan Insulation Marketing Department (see left).



Kingspan Insulation Ltd

Pembridge, Leominster, Herefordshire HR6 9LA, UK
Castleblayney, County Monaghan, Ireland

www.kingspaninsulation.co.uk www.kingspaninsulation.ie